

### Professional Wireless Weather Station With Wind Sensor & Atomic Clock

MODEL # 00992

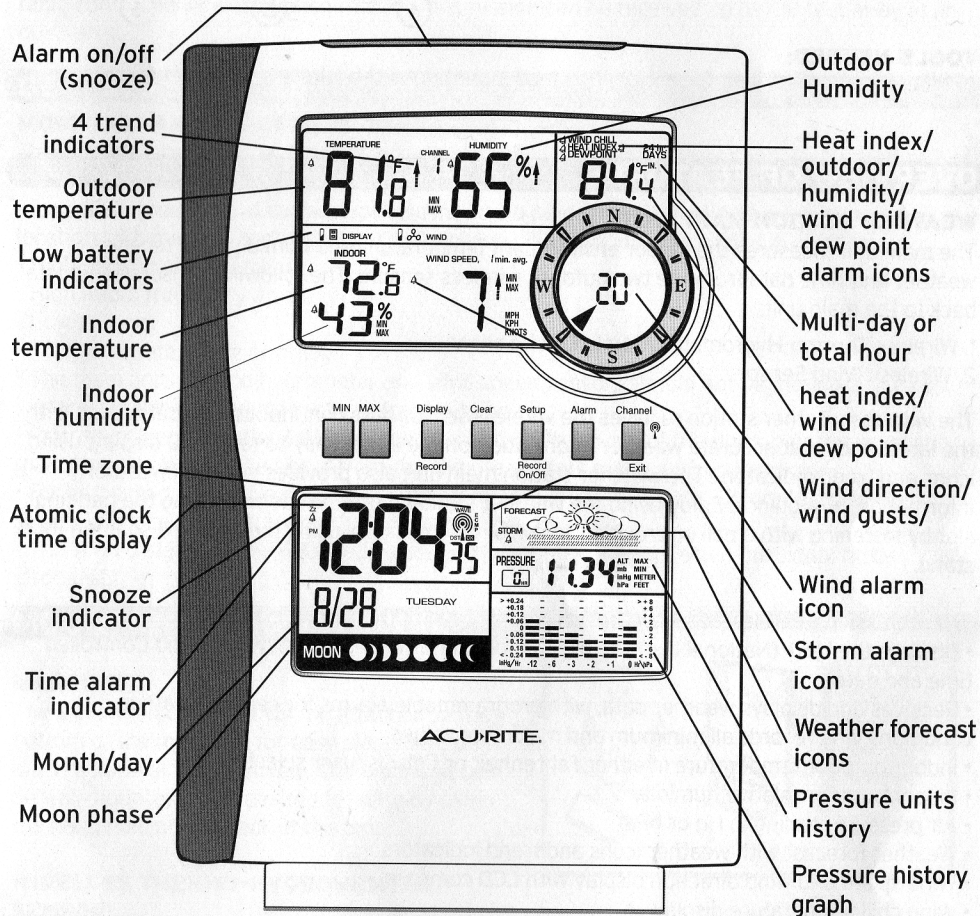

### INTRODUCTION

Thank you for purchasing the ACURITE® professional wireless weather station with wind sensor & atomic clock. This unit is designed and engineered for everyday use in the home, office or wherever weather is of interest. Your new weather station will provide accurate and reliable measurement of wind speed and direction, air pressure, humidity and temperature. The wireless weather station also includes an atomic clock, which receives its signal from the National Institute of Standards and Technology government operated atomic clock in Fort Collins, Colorado. This unit also comes with unique features like wind chill, heat index and dew point calculations. Please read this manual carefully to fully explore the features and benefits of your new weather station.

The ACURITE® professional wireless weather station comes complete with the following items:

1. Main unit with foot stand for desktop use
2. Wireless Thermo-Hygrometer & mounting bracket
3. Wireless Wind speed sensor & mounting bracket
4. Instruction Manual
5. Quick Start Guide
6. Mounting screws & wall anchors

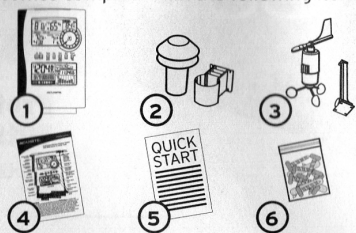

**TOOLS NEEDED:**

- Philips type screwdriver: for optional surface mounting of the wireless sensor / brackets.

**OVERVIEW OF FEATURES**

**WEATHER STATION MAIN UNIT:**

The main unit measures the indoor environment temperature and humidity and receives weather and time data from the two outdoor wireless sensors. The following sensors send data back to the main unit:

1. Wireless Thermo-Hygrometer/Atomic Clock Sensor
2. Wireless Wind Sensor

The wireless weather station receives the wireless sensor data continuously, updating you with the latest and most accurate weather information on the large, easy-to-read LCD display, using icons and trend indicators. The weather station main unit also provides you with weather information, at-a-glance. Enjoy using the weather station either on the wall, using the hanging slot by fastening with a nail or provided screw, or on a desktop, using the included snap-on foot stand.

The professional wireless weather station is composed of the following features:

- Displays the NIST (National Institute of Standards and Technology) WWVB Radio Controlled time and date
- Receives and displays weather data, with programmable alarms for certain weather conditions, and records all minimum and maximum values
- Indoor/outdoor temperature in either Fahrenheit or Celsius (user selectable)
- Indoor/outdoor relative humidity
- Air pressure reading in Hg or hPa
- Weather forecast with weather icons and trend indicators
- Wind speed and wind direction display with LCD compass
- Wind chill temperature display
- Heat index temperature display
- Dew point temperature display
- Time, temperature and storm alarms
- Buttons for use: MAX (+), MIN (-), DISPLAY (daily record), CLEAR, PRESSURE SET-UP (on/off/record), ALARM, CHANNEL (off/wave), SNOOZE (alarm off)

**NIST WWVB RADIO CONTROLLED ATOMIC SIGNAL DESCRIPTION:**

The National Institute of Standards and Technology government operated WWVB atomic radio signal, located in Fort Collins, Colorado, is the most accurate radio signal, used by television, radio and military for the most split-second time and date information. The time and date display on this weather station is based on the signal provided by the atomic clock in Colorado.

**WIRELESS THERMO-HYGROMETER ATOMIC CLOCK SENSOR:**

The thermo-hygrometer atomic clock sensor measures the outdoor temperature and relative humidity. It also includes the radio controlled atomic clock transmitter, which receives data from the atomic clock in Fort Collins, Colorado, and then sends the received data back to the main unit display. The data is sent by a 433MHz radio controlled wireless transmission. Transmission can be received up to 100 feet away in an unobstructed open area.

**WIRELESS WIND SPEED SENSOR:** The wind sensor measures wind speed and wind direction and transmits this information to the main unit display. The data is sent by a 433MHz radio controlled wireless transmission. Transmission can be received up to 100 feet away in an open area.

**GETTING STARTED**

**MOUNTING AND PLACEMENT CONSIDERATIONS:**

The wireless transmission distance from the thermo-hygrometer sensor and wind speed sensor to the main unit in open space under ideal conditions is 100ft. Although the signal transmission may travel through solid surfaces or objects, Try to place the wireless sensors and main unit in a location with minimal obstructions. The following points should be avoided if possible.

- High density of large trees.
- High Radio frequency areas.
- Low-E Glass.
- Thick concrete, stone or brick.
- The main unit, thermo-hygrometer and wind speed sensors should not be mounted to metal surfaces as this can reduce range of transmission.
- Prior to drilling mounting holes and permanently affixing any of the units, please ensure the main unit can receive the signal from the remote sensors in the desired location.
- For best reception of the signal from the atomic clock in Fort Collins, Colorado, place the sensor in a location with a direction towards Colorado.
- The WWVB signal will be obtained easiest in the nighttime hours when the signal is the strongest.

**MOUNTING INSTRUCTIONS**

**MAIN UNIT:**

The included foot mount can be attached to the bottom of the main unit for easy placement on any flat surface. Alternatively, the main unit can be wall mounted in the desired location by using the hang hole on the back of the unit.

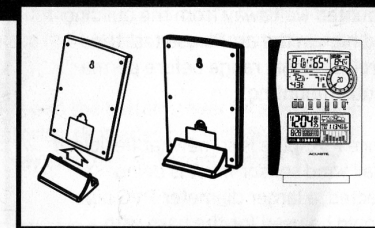

**WIRELESS THERMO-HYGROMETER SENSOR:**

The best place to mount the thermo-hygrometer sensor is in a location out of direct sunlight and protected by extreme weather conditions, such as under the extension of the home roof, under a covered patio or deck. Mount the bracket that the thermo-hygrometer sensor will set in at about eye level by using the four included screws. Once the bracket has been properly affixed in the desired location, place the sensor in the bracket holder. The thermo-hygrometer wireless sensor may also be mounted on a pole; which is outlined in the section "OPTIONAL POLE MOUNTING."

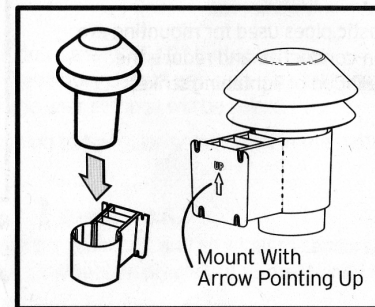

### MOUNTING THE WIRELESS WIND SPEED AND WIND DIRECTION SENSOR:

Before permanently mounting the wind speed bracket, make sure that the wind-fan and wind-vane can rotate freely without any disruption. Also note that the wind speed sensor bracket arm must be pointing north. The wind speed sensor should be positioned to allow the wind to flow around the sensor unhindered from all directions for the most accurate and correct readings.

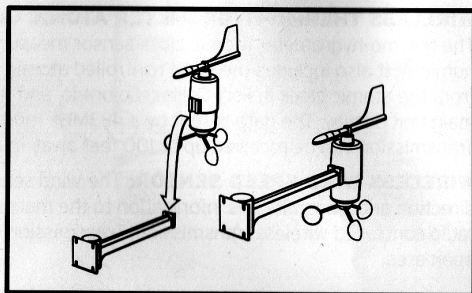

### OPTIONAL POLE MOUNTING:

Both sensors are designed to mount in two ways, either to flat surfaces like wood posts, or to 3/4" schedule 40 PVC pipe (the outside dimension of the pipe actually measures approximately 1, 1/16"). The pipe mounting method is often referred to in these instructions.

The ideal mounting scenario would be for the wireless thermo-hygrometer to be mounted on the north side of the building and for the wind sensor to be mounted well away from the building and high in the air. Please test the wireless signal range before permanently mounting.

Since PVC pipe is somewhat flexible, if a tall wind sensor mast is being erected, a larger diameter PVC pipe should be used for the base with a reducer fitting placed at the top.

Plastic pipes used for mounting are non-conductive and reduce the likelihood of lightning strikes.

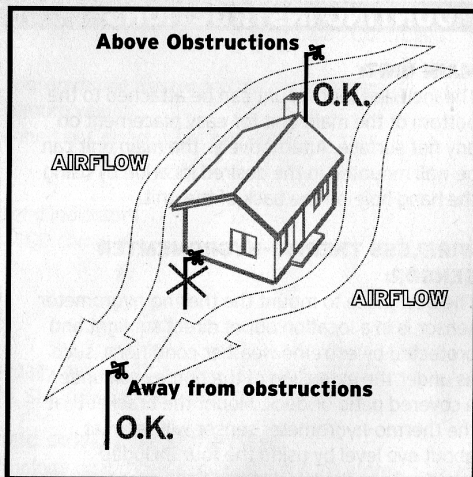
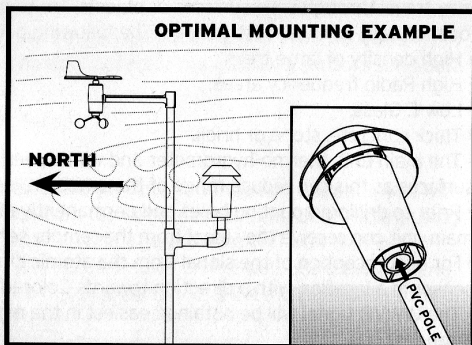

Make sure to place the pole/sensor away from possible wind obstructions to get the most accurate reading.

### BATTERIES (not included)

NOTE: Do not install batteries in any of the units until you have read through the initial set-up steps in their entirety.

#### BATTERY TYPE:

INDOOR UNIT: "AA" (3) alkaline type batteries can be used for the indoor unit.

WIRELESS OUTDOOR UNIT (S): **It is recommended that LITHIUM type "AA" batteries be used in any outdoor units when the temperature drops below -4°F.** Alkaline batteries will freeze at very low temperatures and will fail to provide adequate power to the wireless units.

#### MAIN UNIT BATTERY REPLACEMENT:

When the low battery indicator icon becomes present, it is recommended that you change the batteries. Replace only with the same or equivalent type of fresh alkaline batteries. This method of battery replacement ensures there will be no loss in MIN/MAX and history data. However, if the main unit or sensors have remained without batteries for an extended period of time, the main unit will lose the MIN/MAX memory and all other weather data recordings and will have to be synchronized again.

#### BEFORE INSTALLING BATTERIES:

Before you install the batteries in the main unit, you will need to have the altitude at which the unit will be operating at ready to enter. This step cannot be skipped or returned to during the initial set-up. Visit [www.topozone.com](http://www.topozone.com), consult your local library or call our customer service department at 877-221-1252 for altitude information.

#### BATTERY INSTALLATION:

For the first installation, insert the batteries into the two **WIRELESS SENSORS FIRST** and then into the main unit.

**Thermo-Hygrometer Sensor:** Rotate and pull the top casing from the bottom cone by turning the unit upside down and rotating counter-clock wise until casing pulls apart. Insert 2 fresh alkaline "AA" batteries (batteries not included). Replace the battery compartment cover and rotate the top back into the bottom piece.

**Wind Sensor:** Twist off the top from the bottom and open the battery cover located on the bottom of the sensor. Insert 2 fresh alkaline "AA" batteries. (Batteries not included. Replace battery door cover by putting battery cover on half way and then sliding into place. Twist on the top to the bottom piece.

**Main Unit:** Open the battery cover located on the back of the unit. Remove the screw set provided for wall mount use and insert 3 fresh alkaline "AA" batteries. (Batteries not included). Replace battery door cover.

**NOTE:** When reinstalling the batteries while holding down the "CLEAR" button, all user settings will be cleared and the unit will set back to the factory default settings. If no button is pushed during battery replacement, the last record and user settings will be saved.

**NOTE:** When installing batteries, always install according to the polarity indicated in the battery compartment (+ to + and - to -).

**LOW BATTERY INDICATOR:**  **LOW Battery**  **Battery O.K.**

Low battery indicator is displayed on the main unit for the main unit and all wireless sensors. When replacing the batteries, please follow the battery installation procedure as mentioned in this instruction manual.

## INITIAL SET-UP

### IMPORTANT:

For initial set-up, you will need to have the altitude at which the unit will be operating at ready to enter. This step cannot be skipped or returned to during the initial set-up. Visit [www.topozone.com](http://www.topozone.com), consult your local library or call our customer service department at 877-221-1252 for altitude information.

### POWER ON:

1. Once the batteries have been inserted into the wireless sensors, they will automatically begin transmitting data.
2. IMPORTANT: If you have already installed batteries into the main unit, please remove and re-install to begin initial set-up.
3. Now that the main unit is on, it will show full display for 5 seconds then immediately go into "setting the altitude & forecast mode."

NOTE: The main unit will stay in the altitude and forecast setting mode for 30 seconds before automatically defaulting back into normal operation mode. The altitude and forecast set-up is only available once during initial set-up/initial power up. If this step is missed, simply remove the batteries and start over.

### SETTING THE ALTITUDE AND FORECAST:

The pressure data area will show the default altitude data (300) and the altitude measurement type will be blinking (FEET).

1. Press the "MAX" (+) or "MIN" (-) button to select your altitude measurement type in either METER or FEET. To complete and move to the next step, press the "PRESSURE SET-UP" button.
2. The default altitude will now be blinking, using the "MAX" (+) or "MIN" (-) buttons to set your local altitude. The weather station has a range of -100 to 2500 meter (or from -330 to 8250 feet). To complete and move to the next step, press the "PRESSURE SET-UP" button.
3. The weather forecast icon will now be blinking. Adjust the weather forecast icon using the "MAX" (+) or "MIN" (-) buttons until the forecast icon matches your current weather conditions. Press the "PRESSURE SET-UP" button to confirm or press the "EXIT" button to exit the initial set-up mode.

### SIGNAL RECEPTION:

**OUTDOOR WIRELESS SENSORS:** As soon as the main unit is powered up, it will begin to search for the outdoor wireless sensor signals. While in search mode, the WAVE icon will be animated. During this time, all of the outdoor values will be shown as "----" until the weather data has been received correctly. When the wireless sensor and the main unit battery icons appear, a signal is being received. To force a signal search, **press and hold** the "CHANNEL" button for 3 seconds.

### RADIO CONTROLLED ATOMIC CLOCK:

The Radio Controlled Clock (RCC) signal from Fort Collins, CO is relayed through the wireless thermo-hygrometer sensor. If the RCC signal has successfully been received, "☉" will be displayed. If the RCC signal has not been received, only the icon "▲" will be displayed and always blinking. If the signal has not been received successfully, the reception icon will be blinking, the WAVE icon will be visible, but the OK icon will disappear. To force a signal search, **press and hold** the "CHANNEL" button for 3 seconds.

## GENERAL SET-UP

The general setting mode allows the user to change several product default settings, which is done by simply accessing one setting after the other by pressing the "PRESSURE SET-UP" button. In normal mode, **press and hold** the "PRESSURE SET-UP" button for 3 seconds to enter the manual set-up mode. The icon to set will be blinking. If no key is pressed for 30 seconds, the manual set-up mode returns to the normal display mode. The general programming takes the user through the modes listed below.

While in the set-up mode, use "MAX" (+) or "MIN" (-) buttons to adjust the blinking values. **Press and hold** for rapid scrolling through of the values. Press the "EXIT" button to exit the set-up mode.

1. Manual time setting (hours/minutes), if atomic time is not available.
2. Calendar setting (month/date/year).
3. Time zone setting (P/M/C/E) (Note: zone will be blinking to the right of the WAVE icon).
  - a. P = Pacific Standard Time
  - b. M = Mountain Standard Time
  - c. C = Central Standard Time
  - d. E = Eastern Standard Time
4. Daylight Saving Time setting (ON or OFF)
  - DST ON = Daylight Saving Time enabled.
  - DST OF = Daylight Saving Time disabled.
5. Temperature unit setting (°C or °F)
6. Wind speed unit setting (mph/kph/knots)
7. Air pressure unit setting (mbar/hPa/inHg).

### SELECTABLE DISPLAY MODES:

The following information options can be displayed on the main unit above the digital wind direction compass. Press the "DISPLAY" button to toggle between the below weather data information.

**WIND CHILL:** Wind chill is the rapid cooling of the human body caused by air motion. Air motion accelerates the rate of heat transfer from a human body to the surrounding atmosphere, especially when temperatures are low. The wind chill is a calculation of temperature data from the wireless thermo-hygrometer remote sensor and the wind sensor.

### HEAT INDEX:

Heat index is the perceived temperature to the human body based on both air temperature and the amount of moisture present in the air. The heat index is a calculation based on the combined temperature and humidity data received from the wireless thermo-hygrometer remote sensor.

### DEW POINT:

The dew point temperature is the temperature to which the air must be cooled to reach saturation. The dew point is a calculation of temperature and humidity data received from the wireless thermo-hygrometer remote sensor.

## GENERAL WEATHER STATION FUNCTIONS

After the initial and general set-up, the following data will be displayed in different sections on the main unit display.

### MOON PHASE:

The moon phase indicator, found under the date display, shows the current phase of the moon based on the yearly calendar.

**CALENDAR FUNCTION:** The calendar display, found under the time display shows the current month and date with day indicator.

**FORECAST ICONS:** The main unit predicts weather conditions for the next 12 - 24 hours based on the change in atmospheric pressure. The coverage area is up to 25 miles. Weather forecasts based on atmospheric pressure changes are about 70-75% correct. As weather conditions cannot be 100% correctly forecasted, we cannot be responsible for any loss caused by an incorrect forecast.

One of the following icons will represent the 24 hr. weather forecast :

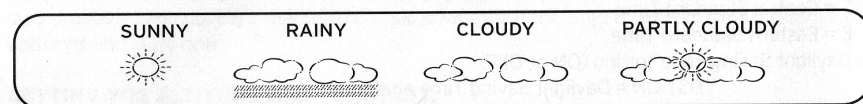

**TREND INDICATORS:** Trend indicators for outdoor temperature and humidity and wind speed show the trend tendency based on the past and current weather conditions.

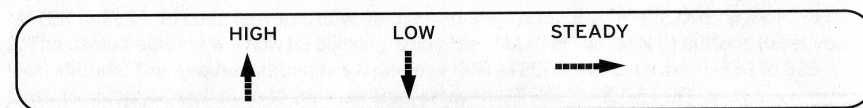

**BAROMETRIC BAR GRAPH AND PRESSURE HISTORY:** The main unit shows BAROMETRIC pressure in two forms, numerically and as a pressure history graph. The graph indicates the pressure changes (range from +0.24inHg to -0.24inHg/ -8hPa mb to +8 hPa mb) of the current and past 1,2,3,6 and 12 hours. The numerical read out can be referenced backwards hour by hour for the past 19 hours by pressing the "PRESSURE SET-UP" button.

### WIND FUNCTIONS:

**Digital Compass:** The digital compass indicates the direction from which the wind is coming from, marked by the arrow indicator, with 16 possible directions. The wind direction is shown here coming out of the **WEST**.

**Wind Gusts:** The wind gust values are located in the center of the digital compass. The wind gusts are transmitted from the wind sensor and are updated approximately every minute. The wind gust shown here is **4** (mph).

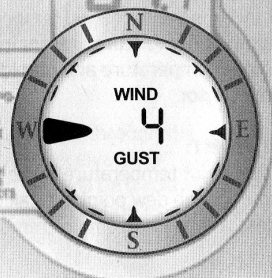

**Wind Speed Average:** The wind speed average is calculated by averaging the wind speed over a period of time.

## WEATHER AND TIME ALARMS

**ALARM SETTING MODE:** The alarm setting mode allows the user to change several alarm settings, which is done by accessing one mode after the other, simply by pressing the "ALARM" button. The individual alarm can be turned on and off by using the "ON/OFF/RECORD" button. When an alarm goes off, an audible tone will sound for one minute.

Press and hold the "ALARM" button for 3 seconds to enter the alarm setting mode. The time display and "AL" for alarm will be blinking. This indicates the user is now in the alarm-setting mode. In alarm setting mode, to activate or deactivate any alarm, press the "PRESSURE SET-UP" button.

For non-time alarms, the blinking "HH.H" means the high alarm value is to be set. For non-time alarms, the blinking "LL.L" means the low alarm value is to be set.

While in the alarm mode, use "MIN" (-) or "MAX" (+) buttons to change any of the values. Press and hold for rapid scroll through of any values. Press the "EXIT" button to exit any of the above alarm modes. Press the "ALARM" button to stop the alarm for one day, or press the "SNOOZE" button to turn the alarm time off for five-minute increments.

This weather station also comes equipped with a audible storm alarm. When activated, the storm alarm will sound if there is a sudden or extreme drop in barometric pressure or if there is a constant progressive drop in barometric pressure. NOTE: If no button is pressed for 30 seconds, the alarm setting mode returns to the normal display mode.

Pressing the "ALARM" button during the alarm-setting mode scrolls through the following settings:

1. Time alarm setting (hours, minutes)
2. Indoor temperature alarm (high, low)
3. Indoor humidity alarm (high, low)
4. Outdoor temperature alarm (high, low, at the current channel)
5. Outdoor humidity alarm (high, low)
6. Wind chill alarm (low)
7. Heat index alarm (high)
8. Dew point alarm (high, low)
9. Wind speed alarm
10. Storm alarm

### MINIMUM & MAXIMUM RECORD MODE

The "MIN/MAX" buttons provide the user with information about the minimum and maximum values of today's weather data. It also acts as an access mode for the daily and long-term records, with the time and date of their recordings.

#### TO ACCESS THE MIN OR MAX VALUES (TODAY'S HIGH'S AND LOW'S):

Press the "MIN" or "MAX" button to display the corresponding highs or lows of the day. When pressing the "MIN" button, the unit will show the minimum value for all the records in the upper display window.

**TO ACCESS THE MIN OR MAX VALUES (CONTINUED):**

When pressing the "MAX" button, the unit will show the maximum value for all the records in the upper display window. Values in the upper display window are as follows; Outdoor temperature, outdoor humidity, indoor temperature, indoor humidity, wind speed average, wind speed gusts, the selectable display item and barometric pressure. Barometric pressure is displayed in the lower display window.

NOTE: To show min/max values for wind chill, heat index, or dew point (the selectable display area), the value of interest must first be displayed by pressing the "DISPLAY" button until the desired value is displayed.

**DAILY RECORDS:**

The Daily Record is a feature that displays a single value with the date and time of its recording. When the daily record is being displayed, the value, date and time will be blinking. When the unit is in a daily record mode, the unit will display a blinking "dr" next to the time of the recording, indicating Daily Record. The main unit automatically stores the last seven days worth of recordings.

**TO ACCESS THE DAILY RECORDS:**

While in either the "MIN" or "MAX" mode, press the "DAILY RECORD" button to show either the "MIN" or "MAX" for any of the values shown in the graph below. Continue to press the "DAILY RECORD" button to scroll through each of the values shown in the graph below.

To review the history of a blinking value, press the "-" or "+" button to scroll backwards and forwards within the last seven days of recordings. The value, date and time will update to show when the record occurred.

NOTE: While reviewing the history for a certain value, pressing the "DAILY RECORD" button automatically returns the unit to the present-day next value as shown in the graph below.

NOTE: Pressing the "exit" button at anytime, returns the unit to normal operating mode.

NOTE: Daily records can not be cleared; they automatically adjust on the seven day cycle.

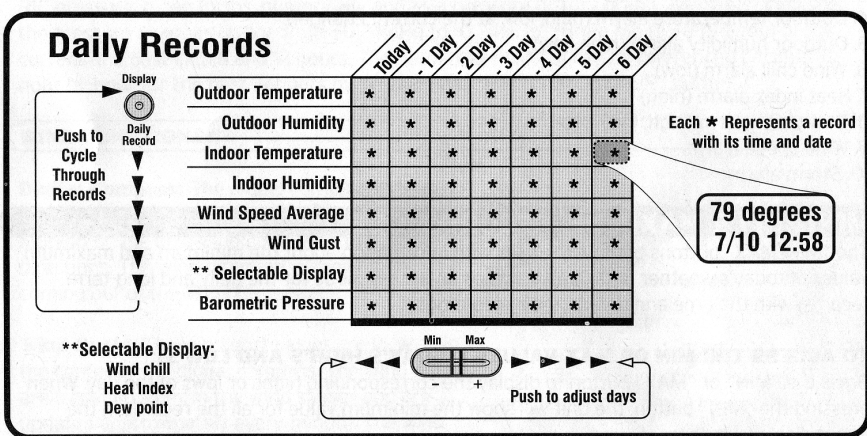

**TO ACCESS THE LONG-TERM RECORDS:**

While in either the "MIN" or "MAX" mode, press the "RECORD" button to show the long-term record highs or lows of the weather station. These values may have occurred anytime in the history of the weather station. These values show the highest or lowest values ever recorded on the weather station.

To review long-term records, press either the "MIN" or "MAX" button, then press the "ON/OFF/RECORD" button to show the highest or lowest value, at this point, the unit will display a blinking "Lr" in the second's window and the unit will show all the record values. To obtain the historical details for these records, press the "ON/OFF/RECORD" button and the record, along with time and date will be blinking. Press the "ON/OFF/RECORD" button again to scroll through each of the unit's minimum and maximum record values.

**CLEARING LONG-TERM RECORDS:**

To clear long-term records, press either the "MIN" or "MAX" button, then press the "ON/OFF/RECORD" button, at this point, the unit will display a blinking "Lr" in the second's window and the unit will show all the record values. Press the "CLEAR" button to clear all the minimum or maximum values. All Long-Term records are cleared at once. This feature is most often used at the beginning or end of a given season. Pressing the "exit" button at anytime, returns the unit to normal operating mode.

**MAINTENANCE**

Clean the housing and screen of the base station only with a soft damp cloth. Do not use abrasives or solvents. Do not submerge in water.

- Clean the outer housing of the thermo-hygrometer sensor with a soft damp cloth. Do not use abrasives or solvents. Do not take sensor apart. Do not clean funnel of sensor. Do not submerge sensor under running water.
- Clean the wind speed and direction sensor only with a soft damp cloth. Do not take sensor apart. Do not use abrasives or solvents. Do not submerge in water.
- Should there be damage to any part of main unit and/or sensors, do not attempt to repair, as this will result in loss of any manufacturer guarantee. Please send damaged part(s) to manufacturer for repair/replacement. Manufacturer information is located at the end of this user manual.

**GENERAL CARE OF MAIN UNIT AND WIRELESS SENSORS:**

- Avoid exposing main unit and wireless sensors to extreme temperatures, keep out of direct sunlight away from water or severe shock.
- When the outside temperature falls below -4°F, the batteries in the wireless sensors may not produce enough current to power the transmitter, if this happens, the main unit will not show an outdoor temperature reading. We recommend the thermo-hygrometer wireless sensor be brought indoors during prolonged periods of sub-freezing temperatures.

**CHANGING BATTERIES**

**MAIN UNIT BATTERY REPLACEMENT:** When the low battery indicator icon becomes present, it is recommended that you change the batteries. Replace only with the same or equivalent type of fresh alkaline batteries. This method of battery replacement ensures there will be no loss in MIN/MAX and history data. However, if main unit or sensors have remained without batteries for an extended period of time, the main unit will lose the MIN/MAX and all weather data recordings and will have to be synchronized again.

NOTE: When replacing batteries, do not mix battery types or old batteries with new ones.

## WIRELESS SENSOR BATTERY REPLACEMENT:

When the low battery indicator icon becomes present, it is recommended that you change the batteries. Replace only with the same or equivalent type of fresh alkaline batteries. This method of battery replacement ensures there will be no loss in MIN/MAX and history data. However, if main unit or sensors have remained without batteries for an extended period of time, the main unit will lose the MIN/MAX and all weather data recordings and will have to be synchronized again.

## ACCESSING THE BATTERY COMPARTMENTS

**Main Unit:** Open the battery cover located on the back of the unit. Remove the screw set provided for wall mount use and insert 3 fresh "AA" batteries. (Batteries not included). Replace battery door cover.

**Thermo-Hygrometer Sensor:** Rotate and pull the top casing from the bottom cone by turning the unit upside down and rotating counter-clockwise until casing pulls apart. Slide the battery compartment cover (located on the side of the sensor) off. Insert 2 fresh "AA" batteries (batteries not included). Replace the battery compartment cover and rotate the top back into the bottom piece.

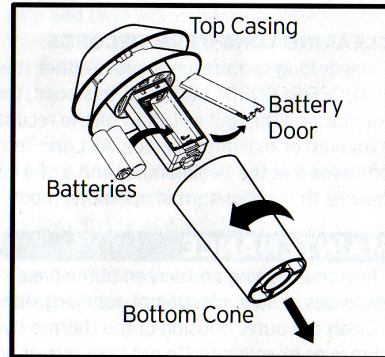

**Wind Sensor:** Twist off the top from the bottom and open the battery cover located on the bottom of the sensor. Insert 2 fresh "AA" batteries. (Batteries not included). Replace battery door cover by putting battery cover on half way and then sliding into place. Twist on the top to the bottom piece.

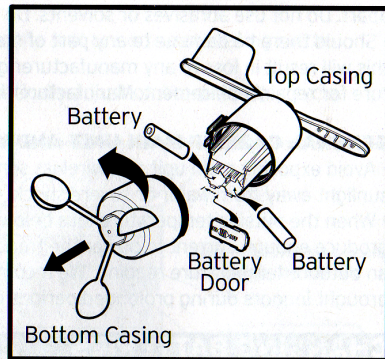

NOTE: When reinstalling the batteries while holding down the "CLEAR" button, all user settings will be cleared and the unit will set back to the factory default settings. If no button is pushed during battery replacement, the last record and user settings will be saved.

NOTE: When installing batteries, always install according to the polarity indicated in the battery compartment.

## REFERENCE

### BUTTON OPERATION DESCRIPTIONS:

The main unit has 8 buttons for user operation. Please refer to the following for button operation description:

- 1. MIN BUTTON:** Press the "MIN" button to enter the MIN MODE. The "MIN" icon on the main unit will be displayed. Press the "EXIT" button to exit the MIN MODE. The "MIN" icon will disappear.
- 2. MAX BUTTON:** Press the "MAX" button to enter the MAX MODE. The "MAX" icon on the main unit will be displayed. Press the "EXIT" button to exit the MAX MODE. The "MAX" icon will disappear.
- 3. DISPLAY (DAILY RECORD) BUTTON:** Press the "DISPLAY" button to toggle between the following information in the upper right hand side of the main unit: WIND CHILL, HEAT INDEX, DEW POINT.
- 4. CLEAR BUTTON:** Press the "CLEAR" button to clear any settings currently stored in the main unit.
- 5. PRESSURE SET-UP (ON/OFF/RECORD) BUTTON:** Press the "PRESSURE SET-UP" button to view the past 19 hours of recorded air pressure. Press and hold for 3 seconds to enter the general set-up mode.
- 6. ALARM BUTTON:** Press the "ALARM" button to stop any alarm for one day when the alarm sounds. Press and hold for 3 seconds to enter the alarm set-up mode.
- 7. CHANNEL (EXIT) BUTTON:** Press the "CHANNEL" button to view the outdoor temperature and humidity for any additional sensors used. Additional sensors are sold separately. Additional sensors are optional. Press and hold the "CHANNEL" button will force the main unit into signal searching mode.

NOTE: Pressing the "EXIT" button will exit all of the MIN/MAX, SET-UP, and ALARM settings while in these modes.

- 8. SNOOZE BUTTON:** Press the "SNOOZE" button to enter into the snooze mode for 5 minutes when the time alarm is activated. The ALARM icon will be displayed and blinking.

NOTE: In set-up and alarm setting mode, pressing either the "MIN" or "MAX" buttons will allow the user to change any values. The user may press and hold the button for rapid scroll through of values.

### FUNCTION BUTTONS

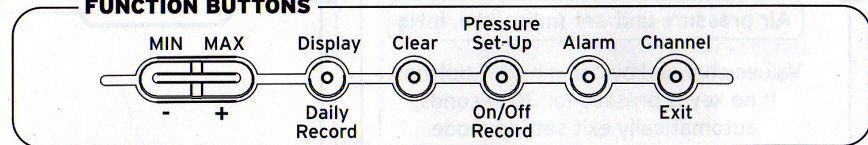

# REFERENCE: OPERATION FLOW CHART

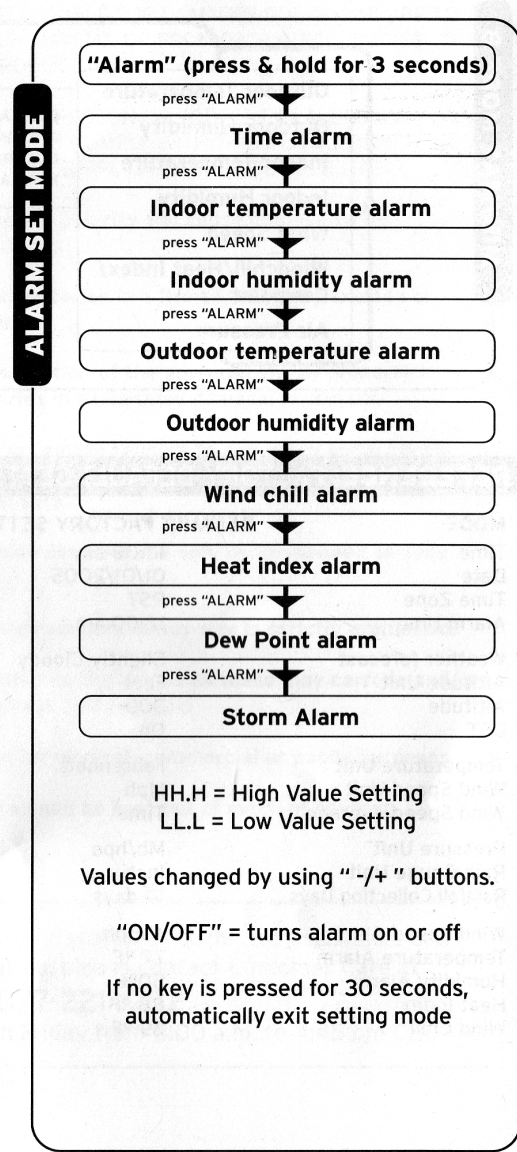
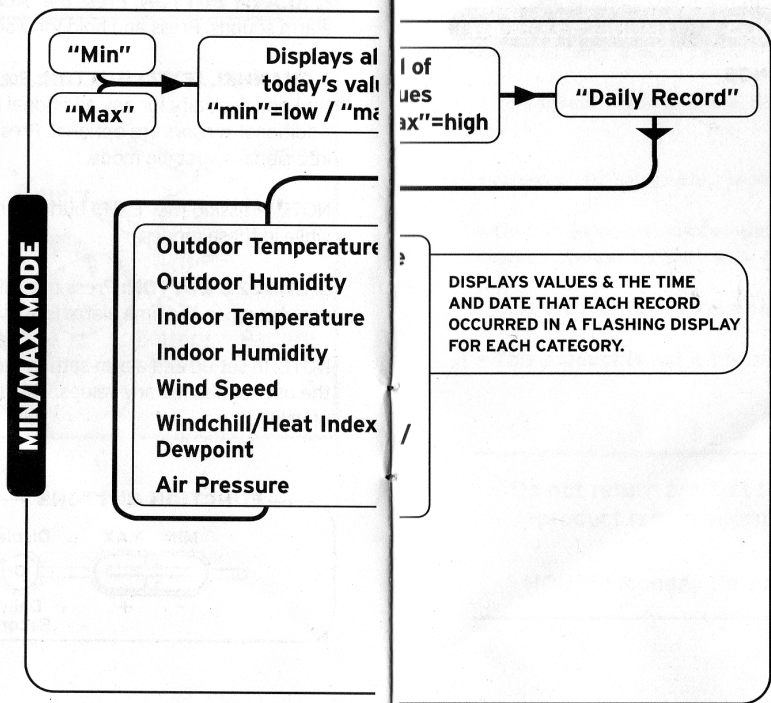
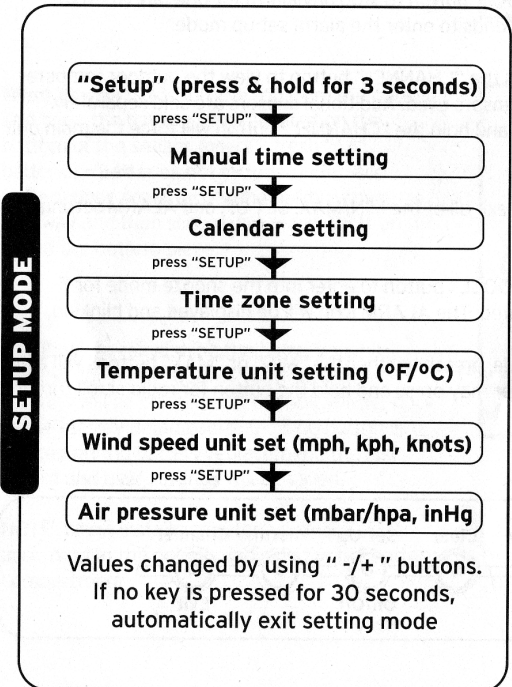
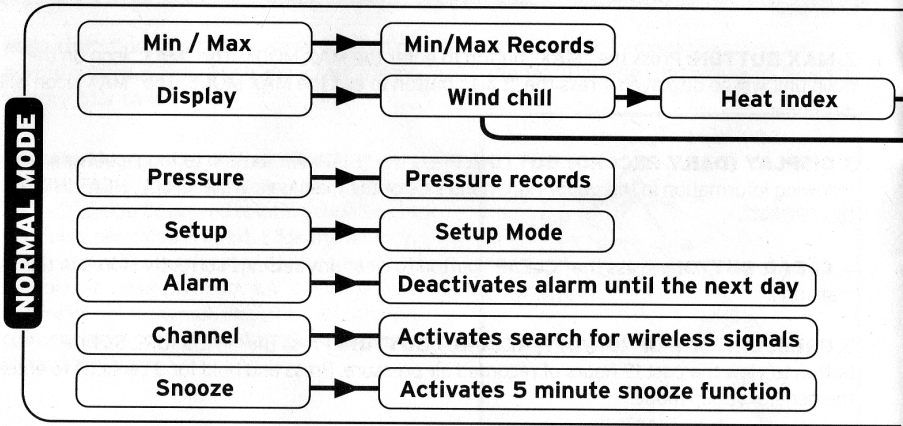
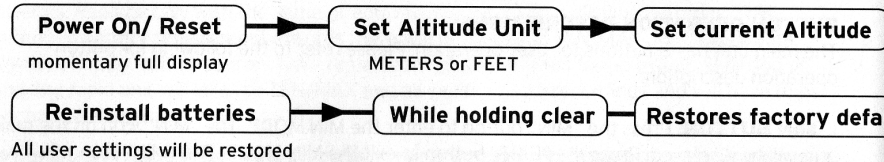



## REFERENCE: OPERATION FLOW CHART (continued)

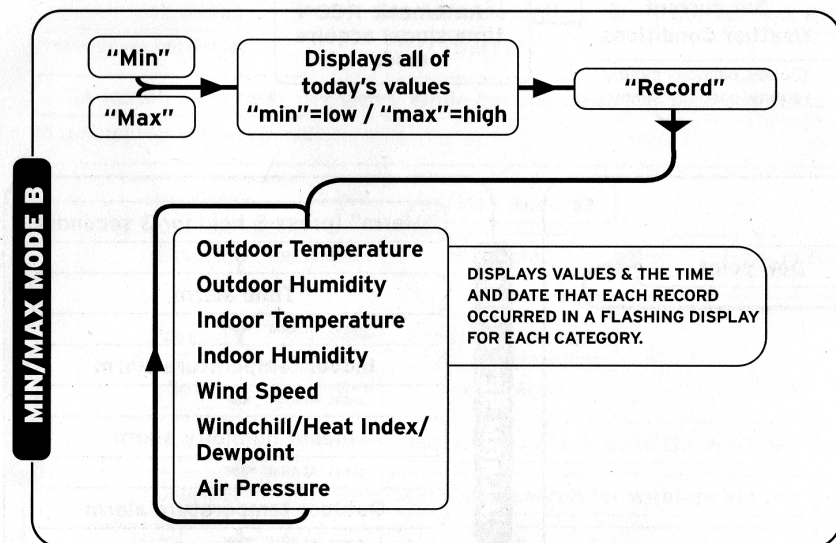

## REFERENCE: FACTORY DEFAULT SETTINGS MODEL# 00594W

MODE	DEFAULT FACTORY SETTINGS
Time	12:00 am
Date	01/01/2005
Time Zone	PST
Alarm time	12:00 am
Weather forecast	Slightly Cloudy
Altitude Unit	Feet
Altitude	300
DST	On
Temperature Unit	Fahrenheit
Wind Speed Unit	Mph
Wind Speed Average	Time
Pressure Unit	Mb/hpa
Rain Gauge Unit	Inch
Rainfall Collection Days	14 days
Wind Speed Alarm	6 mph
Temperature Alarm	77 °F
Humidity Alarm	50%
Heat Index	86 °F
Wind Chill	59 °F

## SAFETY

### IMPORTANT INFORMATION REGARDING YOUR NEW ACURITE WIRELESS WEATHER STATION WITH REMOTE WIND SPEED AND ATOMIC CLOCK

#### SAFETY:

DAMAGE CAUSED BY FAILURE TO COMPLY WITH THIS INSTRUCTION MANUAL WILL INVALIDATE ANY MANUFACTURER GUARANTEE. THE MANUFACTURER AND SUPPLIER WILL NOT BE HELD LIABLE FOR DAMAGES DUE TO FAILURE TO COMPLY WITH THIS INSTRUCTION MANUAL OR FROM DATA INACCURACIES THAT MAY OCCUR WITH THIS PRODUCT.

IN CASE OF HARM OR DAMAGE TO A PERSON OR PROPERTY CAUSED BY IMPROPER HANDLING OR FAILURE TO COMPLY WITH THIS INSTRUCTION MANUAL, THE MANUFACTURER AND SUPPLIER CANNOT BE HELD LIABLE.

- Inserting batteries in an incorrect polarity will cause damage to this weather station and remote sensors.
- Do not dispose of new or used batteries in a fire as they may explode or could release dangerous chemicals.
- Please participate in the preservation of the environment by properly disposing of all discarded batteries in designated disposal receptors.
- Do not subject the main unit or remote sensors to excessive force, shock, dust, temperature or humidity, as these conditions may shorten the life of the main unit and/or remote sensors.
- To operate main unit and remote sensors, use only recommended battery types.
- Altering the main unit or remote sensors in any way is strictly prohibited.
- Do not leave discharged batteries in the device as these may corrode and/or release chemicals that may damage this product.
- This product is not to be used for medical, commercial or public purposes.
- This product is not a toy and should be kept out of reach of children.

Do not return product to retail store. For Technical Assistance and product return information, please contact Customer Care at:

**877-221-1252**

HOURS: Monday through Friday from 8:00 a.m. to 4:45 pm CST.



**Please DO NOT return product to the retail store.**

For technical assistance and product return information, please call  
Customer Care: **877-221-1252** Mon. - Fri. 8:00 A.M. to 4:45 P.M. (CST)

[www.chaneyinstrument.com](http://www.chaneyinstrument.com)

**LIMITED ONE YEAR WARRANTY**

Chaney Instrument Company warrants that all products it manufactures to be of good material and workmanship and to be free of defects if properly installed and operated for a period of one year from date of purchase. REMEDY FOR BREACH OF THIS WARRANTY IS EXPRESSLY LIMITED TO REPAIR OR REPLACEMENT OF DEFECTIVE ITEMS. Any product which, under normal use and service, is proven to breach the warranty contained herein within ONE YEAR from date of sale will, upon examination by Chaney, and at its sole option, be repaired or replaced by Chaney. In all cases, transportation costs and charges for returned goods shall be paid for by the purchaser. Chaney hereby disclaims all responsibility for such transportation costs and charges. This warranty will not be breached, and Chaney will give no credit for products it manufactures which shall have received normal wear and tear, been damaged, tampered, abused, improperly installed, damaged in shipping, or repaired or altered by others than authorized representatives of Chaney.

THE ABOVE-DESCRIBED WARRANTY IS EXPRESSLY IN LIEU OF ALL OTHER WARRANTIES, EXPRESS OR IMPLIED, AND ALL OTHER WARRANTIES ARE HEREBY EXPRESSLY DISCLAIMED, INCLUDING WITHOUT LIMITATION THE IMPLIED WARRANTY OF MERCHANTABILITY AND THE IMPLIED WARRANTY OF FITNESS FOR A PARTICULAR PURPOSE. CHANEY EXPRESSLY DISCLAIMS ALL LIABILITY FOR SPECIAL, CONSEQUENTIAL OR INCIDENTAL DAMAGES, WHETHER ARISING IN TORT OR BY CONTRACT FROM ANY BREACH OF THIS WARRANTY. SOME STATES DO NOT ALLOW THE EXCLUSION OR LIMITATION OF INCIDENTAL OR CONSEQUENTIAL DAMAGES, SO THE ABOVE LIMITATION OR EXCLUSION MAY NOT APPLY TO YOU. CHANEY FURTHER DISCLAIMS ALL LIABILITY FROM PERSONAL INJURY RELATING TO ITS PRODUCTS TO THE EXTENT PERMITTED BY LAW. BY ACCEPTANCE OF ANY OF CHANEY'S EQUIPMENT OR PRODUCTS, THE PURCHASER ASSUMES ALL LIABILITY FOR THE CONSEQUENCES ARISING FROM THEIR USE OR MISUSE. NO PERSON, FIRM OR CORPORATION IS AUTHORIZED TO ASSUME FOR CHANEY ANY OTHER LIABILITY IN CONNECTION WITH THE SALE OF ITS PRODUCTS. FURTHERMORE, NO PERSON, FIRM OR CORPORATION IS AUTHORIZED TO MODIFY OR WAIVE THE TERMS OF THIS PARAGRAPH, AND THE PRECEDING PARAGRAPH, UNLESS DONE IN WRITING AND SIGNED BY A DULY AUTHORIZED AGENT OF CHANEY. THIS WARRANTY GIVES YOU SPECIFIC LEGAL RIGHTS, AND YOU MAY ALSO HAVE OTHER RIGHTS WHICH VARY FROM STATE TO STATE.

**For in-warranty repair, please contact:**

Customer Care Department  
Chaney Instrument Company  
965 Wells Street  
Lake Geneva, WI 53147

**Chaney Customer Care**

**877-221-1252**  
**Mon-Fri 8:00 a.m. to 4:45 p.m. CST**

[www.chaneyinstrument.com](http://www.chaneyinstrument.com)



This device complies with part 15 of the FCC rules. Operation is subject to the following two conditions:

- 1- This device may NOT cause harmful interference, and
- 2- This device must accept any interference received, including interference that may cause undesired operation.

NOTE: This equipment has been tested and found to comply with the limits for a Class B digital device, pursuant to Part 15 of the FCC rules. These limits are designed to provide reasonable protection against harmful interference in a residential installation. This equipment generates, uses and can radiate radio frequency energy and, if not installed and used in accordance with the instructions, may cause harmful interference to radio communications. However, there is no guarantee that interference will not occur in a particular installation. If this equipment does cause harmful interference to radio or television reception, which can be determined by turning the equipment off and on, the user is encouraged to try to correct the interference by one or more of the following measures:

- Reorient or relocate the receiving antenna.
- Increase the separation between the equipment and the receiver.
- Connect the equipment into an outlet on a circuit different from that to which the receiver is connected
- Consult the dealer or an experienced radio/TV technician for help.

NOTE: The manufacturer is not responsible for any radio or TV interference caused by unauthorized modifications to this equipment. Such modifications could void the user authority to operate the equipment.

Patent numbers: 5,978,738; 6,076,044; 6,597,990

The ACURITE, professional wireless weather station comes complete with the following items:

1. Main unit with foot stand for desktop use
2. Thermo-Hygrometer with mounting bracket
3. Wind speed sensor with mounting bracket
4. Instruction Manual
5. Quick Start Guide
6. Mounting screws

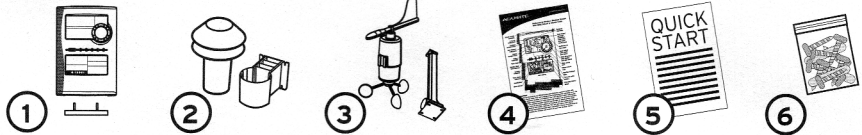

#### TOOLS NEEDED:

- #1 philips-type screwdriver: to access battery compartment on the Thermo-Hygrometer Remote Sensor
- #2 philips type screwdriver: for optional surface mounting of the remote sensor(s).

#### DO NOT RETURN PRODUCT TO STORE

Customer Support: Toll-free support hotline at 877.221.1252 (HOURS: Monday through Friday from 8:00 a.m. to 4:45 pm CST)

Should this product from Chaney Instrument Co., prove to be defective in material or workmanship or further information is needed, please do not return to the retail store. Please call our Toll-free support hotline at 877.221.1252

#### IMPORTANT:

For initial set-up, you will need to have the altitude at which the unit will be operating at ready to enter. This step cannot be skipped or returned to during the initial set-up. Visit [www.topozone.com](http://www.topozone.com), consult your local library or call our customer service department at 877-221-1252 for altitude information.

#### A INSTALLING BATTERIES: (7 "AA" Alkaline Batteries Required- not included)

For the first installation, insert the batteries into the **two remote sensors first** and then into the main unit. Use lithium batteries in the outside sensors for temperatures below -4°F.

1. **Thermo-Hygrometer Sensor:** Rotate and pull the top casing from the bottom cone by turning the unit upside down and rotating counter-clock wise until casing pulls apart. Remove the 4 screws in the battery compartment cover located on the side of the sensor. Insert 2 fresh alkaline "AA" batteries (batteries not included). Replace the battery compartment cover and rotate the top back into the bottom piece.
2. **Wind Sensor:** Twist off the top from the bottom and open the battery cover located on the bottom of the sensor. Insert 2 fresh "AA" alkaline batteries. (Batteries not included). Replace battery door cover. Twist on the top to the bottom piece.
3. **Main Unit:** Open the battery cover located on the back of the unit. Remove the screw set provided for wall mount use and insert 3 fresh alkaline "AA" batteries. (Batteries not included). Replace battery door cover.

#### B POWER ON:

1. Once the batteries have been inserted into the remote sensors, they will automatically begin transmitting data.
2. IMPORTANT: If you have already installed batteries into the main unit, please remove and re-install to begin initial set-up.
3. As the unit powers up, the display will fully illuminate for 5 seconds, they are considered on and ready to be operated. The main unit will show full display for 5 seconds then immediately go into "setting the altitude and forecast mode."

**NOTE:** The main unit will stay in the altitude and forecast setting mode for 30 seconds before automatically defaulting back into normal mode. The altitude and forecast set-up is only available during initial set-up/initial power up.

#### C SETTING THE ALTITUDE AND FORECAST:

The pressure data area will show the default altitude data (300) and the altitude measurement type will be blinking (FEET).

1. Press the "MAX" (+) or "MIN" (-) button to select your altitude measurement type in either METER or FEET. To complete and move to the next step, press the "PRESSURE SET-UP" button.
2. The default altitude will now be blinking, using the "MAX" (+) or "MIN" (-) buttons to set your local altitude. The weather station has a range of -100 to 2500 meter (or from -330 to 8250 feet). To complete and move to the next step, press the "PRESSURE SET-UP" button.
3. The weather forecast icon will now be blinking. Adjust the weather forecast icon using the "MAX" (+) or "MIN" (-) buttons until the forecast icon matches your current weather conditions. Press the "PRESSURE SET-UP" button to confirm and move on to the next setting mode, or press the "EXIT" button to exit the initial set-up mode.

#### D GENERAL SETUP:

The "PRESSURE SETUP" button will cycle you through more default setting modes. To adjust a default setting, use the "-" or "+" buttons. The following default settings can be changed at this time in the following sequence. Press the "EXIT" button to exit the setup mode at any time.

**Manual time setting** (hours,minutes - if atomic time signal is unavailable) / **Calendar** (month,date,year) / **Time zone** (P,M,C,E) / **Daylight saving time** (on or off) / **Temperature display unit** (°F or °C) / **Wind speed display unit** (mph,kph,knots) / **Wind speed average time setting** (1 to 18 mins- the wind speed number displayed is an average number based on measurements taken over a preset time period) / **Air pressure display unit** (mbar, hPa, inHg)

#### SIGNAL RECEPTION:

**OUTDOOR SENSORS:** As soon as the main unit is powered up, it will begin to search for the outdoor remote sensor signals. While in search mode, the WAVE icon will be animated. During this time, all of the outdoor values will be shown as "----" until the weather data has been received correctly. The sensor and main unit battery icons will now be displayed.

**RADIO CONTROLLED ATOMIC CLOCK:** The Radio Controlled Clock (RCC) signal from Fort Collins, CO is relayed through the wireless thermo-hygrometer sensor. If the RCC signal has successfully been received, "☉" will be displayed. If the RCC signal has not been received, only the icon "▲" will be displayed and always blinking. If the signal has not been received successfully, the reception icon will be blinking, the WAVE icon will be visible, but the OK icon will disappear. To force a signal search, press and hold the "CHANNEL" button for 3 seconds.